

### General Description

The AAT4280 SmartSwitch™ is a member of AATI's Application Specific Power MOSFET™ (ASPM™) product family. The AAT4280 is a P-channel MOSFET power switch designed for high-side load-switching applications. The P-channel MOSFET device has a typical  $R_{DS(ON)}$  of  $80m\Omega$ , allowing increased load switch power handling capacity. This device is available in three different versions with flexible turn on and off characteristics from very fast to slew rate limited. The standard AAT4280 (-1) version has a slew rate limited turn on load switch and is functionally compatible with the AAT4250 device while offering superior  $R_{DS(ON)}$  characteristics. The AAT4280 (-2) version features fast load switch turn on capabilities, typically less than 500ns turn on and 3 $\mu$ s turn off times. The AAT4280 (-3) variation offers a shutdown load discharge circuit to rapidly turn off a load circuit when the switch is disabled. All AAT4280 load switch versions operate with an input voltage ranging from 1.8V to 5.5V, making them ideal for both 3V and 5V systems. The AAT4280 also features an under voltage lock out which turns the switch off when an input under-voltage condition exists. Input logic levels are TTL and 2.5 volt to 5 volt CMOS compatible. The quiescent supply current is very low, typically 2.5 $\mu$ A. In shutdown mode, the supply current decreases to less than 1 $\mu$ A.

The AAT4280 is available in a 6 pin SOT23 or 8 pin SC70JW package and is specified over -40°C to 85°C temperature range.

### Features

- 1.8V to 5.5V Input voltage range
- Very Low  $R_{DS(ON)}$ , typically  $80m\Omega$  (5V)
- Slew rate limited turn-on time options
  - 1ms
  - 0.5 $\mu$ s
  - 100 $\mu$ s
- Fast shutdown load discharge option
- Low quiescent current
  - 2.5 $\mu$ A typ
  - 1 $\mu$ A max in shutdown
- TTL/CMOS input logic level
- Temperature range -40°C to 85°C
- 4kV ESD rating
- 6 pin SOT23 or SC70JW-8 package

### Applications

- Cellular telephones
- Digital still cameras
- Personal digital assistants (PDA)
- Hot swap supplies
- Notebook computers
- Personal communication devices

### Typical Application

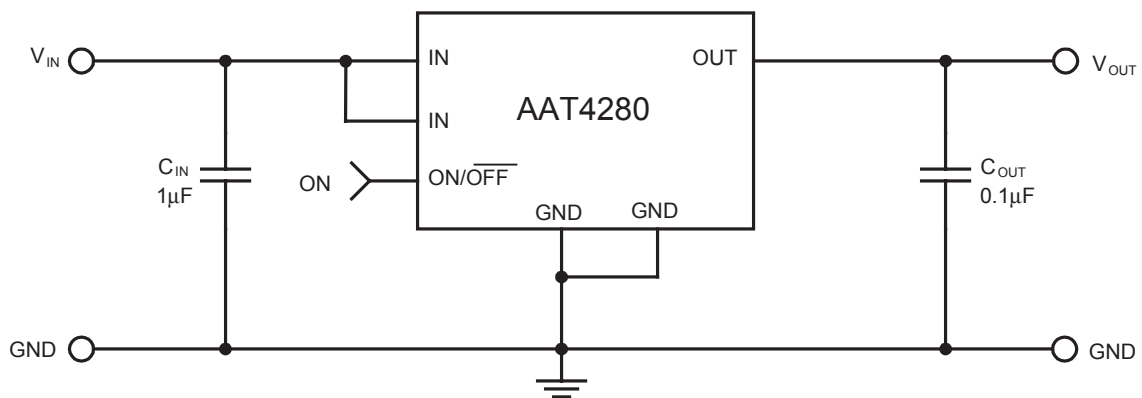

### Pin Descriptions

| Pin #   |           | Symbol | Function   |
|---------|-----------|--------|--|
| SOT23-6 | SC70JW    |        |  |
| 1       | 2         | OUT    | The pin is the P-channel MOSFET drain connection. Bypass to ground through a 0.1uF capacitor.    |
| 2,5     | 4         | GND    | Ground connection  |
| 3       | 3         | ON/OFF | Enable Input   |
| 4,6     | 1,5,6,7,8 | IN     | The pin is the input to the P-channel MOSFET source. Bypass to ground through a 1.0uF capacitor. |

### Pin Configuration

**SOT23-6  
(Top View)**

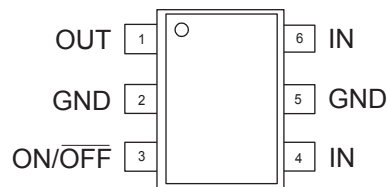

**SC70JW-8  
(Top View)**

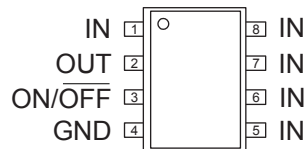

### Selector Guide

| Part Number | Slew Rate (typ) | Active Pull Down | Enable      |
|-------------|-----------------|------------------|-------------|
| AAT4280-1   | 1mS             |                  | Active High |
| AAT4280-2   | 0.5μS           |                  | Active High |
| AAT4280-3   | 100μS           | √                | Active High |

### Absolute Maximum Ratings ( $T_A=25^\circ\text{C}$ unless otherwise noted)

| Symbol     | Description                              | Value                | Units            |   |
|------------|--|----------------------|------------------|---|
| $V_{IN}$   | IN to GND                                | -0.3 to 6            | V                |   |
| $V_{ON}$   | ON/OFF to GND                            | -0.3 to 6            | V                |   |
| $V_{OUT}$  | OUT to GND                               | -0.3 to $V_{IN}+0.3$ | V                |   |
| $I_{MAX}$  | Maximum Continuous Switch Current        | 2.3                  | A                |   |
| $I_{DM}$   | Maximum Pulsed Current                   | $IN \geq 2.5V$       | 6                | A |
|            |  | $IN < 2.5V$          | 3                | A |
| $T_J$      | Operating Junction Temperature Range     | -40 to 150           | $^\circ\text{C}$ |   |
| $T_{LEAD}$ | Maximum Soldering Temperature (at Leads) | 300                  | $^\circ\text{C}$ |   |
| $V_{ESD}$  | ESD Rating <sup>1</sup> - HBM            | 4000                 | V                |   |

Note: Stresses above those listed in Absolute Maximum Ratings may cause permanent damage to the device. Functional operation at conditions other than the operating conditions specified is not implied. Only one Absolute Maximum rating should be applied at any one time.

Note 1: Human body model is a 100pF capacitor discharged through a 1.5k $\Omega$  resistor into each pin.

### Thermal Characteristics

| Symbol        | Description   | Value   |          | Units                     |
|---------------|---|---------|----------|---------------------------|
|               |   | SOT23-6 | SC70JW-8 |                           |
| $\Theta_{JA}$ | Thermal Resistance (SOT23-6 or SC70JW-8) <sup>2</sup> | 120     | 140      | $^\circ\text{C}/\text{W}$ |
| $P_D$         | Power Dissipation (SOT23-6 or SC70JW-8) <sup>2</sup>  | 833     | 714      | mW                        |

Note 2: Mounted on an AAT4280 demo board in still 25 $^\circ\text{C}$  air.

**Electrical Characteristics** ( $V_{IN} = 5V$ ,  $T_A = -40$  to  $85^\circ C$  unless otherwise noted. Typical values are at  $T_A = 25^\circ C$ )

| Symbol                      | Description                                   | Conditions   | Min              | Typ  | Max  | Units           |
|-----------------------------|---|--|------------------|------|------|-----------------|
| <b>AAT4280 All Versions</b> |   |  |                  |      |      |                 |
| $V_{IN}$                    | Operation Voltage                             |  | 1.8 <sup>3</sup> |      | 5.5  | V               |
| $V_{UVLO}$                  | Undervoltage Lockout                          | $V_{IN}$ falling   | 1.0              | 1.4  | 1.8  | V               |
| $V_{UVLO(hys)}$             | Undervoltage Lockout Hysteresis               |  |                  | 250  |      | mV              |
| $I_Q$                       | Quiescent Current                             | ON/ $\overline{OFF}$ = active                              |                  | 2.5  | 4    | $\mu A$         |
| $I_{Q(off)}$                | Off supply current                            | ON/ $\overline{OFF}$ = inactive, OUT=open                  |                  |      | 1    | $\mu A$         |
| $I_{SD(off)}$               | Off switch current                            | ON/ $\overline{OFF}$ = inactive, $V_{OUT}=0$               |                  |      | 1    | $\mu A$         |
| $R_{DS(on)}$                | On -resistance                                | $V_{IN}=5V$ , $T_A=25^\circ C$                             |                  | 80   | 120  | m $\Omega$      |
|                             |   | $V_{IN}=4.2V$ , $T_A=25^\circ C$                           |                  | 85   | 130  |                 |
|                             |   | $V_{IN}=3V$ , $T_A=25^\circ C$                             |                  | 100  | 150  |                 |
|                             |   | $V_{IN}=1.8V$ , $T_A=25^\circ C$                           |                  | 160  | 250  |                 |
| $TC_{RDS}$                  | On-Resistance Temp -Co                        |  |                  | 2800 |      | ppm/ $^\circ C$ |
| $V_{IL}$                    | ON/ $\overline{OFF}$ Input Logic Low Voltage  | $V_{IN}=2.7V-5.5V$ <sup>4</sup>                            |                  |      | 0.8  | V               |
| $V_{IH}$                    | ON/ $\overline{OFF}$ Input Logic High Voltage | $V_{IN}=2.7V$ to $\leq 4.2V$                               | 2                |      |      | V               |
|                             |   | $V_{IN} = >4.2V$ to $5.5V$                                 | 2.4              |      |      | V               |
| $I_{SINK}$                  | ON/ $\overline{OFF}$ Input Leakage            | $V_{ON/\overline{OFF}} = 5.5V$                             |                  |      | 1    | $\mu A$         |
| <b>AAT4280-1</b>            |   |  |                  |      |      |                 |
| $T_{D(ON)}$                 | Output Turn-On Delay                          | $V_{IN} = 5V$ , $R_{LOAD} = 10\Omega$ , $T_A = 25^\circ C$ |                  | 20   | 40   | $\mu S$         |
| $T_{ON}$                    | Output Turn-On rise time                      | $V_{IN} = 5V$ , $R_{LOAD} = 10\Omega$ , $T_A = 25^\circ C$ |                  | 1000 | 1500 | $\mu S$         |
| $T_{D(OFF)}$                | Output Turn-Off delay time                    | $V_{IN} = 5V$ , $R_{LOAD} = 10\Omega$ , $T_A = 25^\circ C$ |                  | 4    | 10   | $\mu S$         |
| <b>AAT4280-2</b>            |   |  |                  |      |      |                 |
| $T_{D(ON)}$                 | Output Turn-On Delay                          | $V_{IN} = 5V$ , $R_{LOAD} = 10\Omega$ , $T_A = 25^\circ C$ |                  | 0.5  | 2    | $\mu S$         |
| $T_{ON}$                    | Output Turn-On rise time                      | $V_{IN} = 5V$ , $R_{LOAD} = 10\Omega$ , $T_A = 25^\circ C$ |                  | 0.5  | 1    | $\mu S$         |
| $T_{D(OFF)}$                | Output Turn-Off delay time                    | $V_{IN} = 5V$ , $R_{LOAD} = 10\Omega$ , $T_A = 25^\circ C$ |                  | 4    | 10   | $\mu S$         |
| <b>AAT4280-3</b>            |   |  |                  |      |      |                 |
| $T_{D(ON)}$                 | Output Turn-On Delay                          | $V_{IN} = 5V$ , $R_{LOAD} = 10\Omega$ , $T_A = 25^\circ C$ |                  | 20   | 40   | $\mu S$         |
| $T_{ON}$                    | Output Turn-On rise time                      | $V_{IN} = 5V$ , $R_{LOAD} = 10\Omega$ , $T_A = 25^\circ C$ |                  | 100  | 150  | $\mu S$         |
| $T_{D(OFF)}$                | Output Turn_Off delay time                    | $V_{IN} = 5V$ , $R_{LOAD} = 10\Omega$ , $T_A = 25^\circ C$ |                  | 4    | 10   | $\mu S$         |
| $R_{PD}$                    | Output pull-down resistance during OFF        | ON/ $\overline{OFF}$ = inactive, $T_A = 25^\circ C$        |                  | 150  | 250  | $\Omega$        |

Note 3: Part requires minimum start-up of  $V_{IN} \geq 2.0V$  to ensure operation down to 1.8V

Note 4: For  $V_{IN}$  outside this range consult typical ON/ $\overline{OFF}$  threshold curve.

### Typical Characteristics

(Unless otherwise noted,  $V_{IN} = 5V$ ,  $T_A = 25^\circ C$ )

**Quiescent Current vs. Temperature**

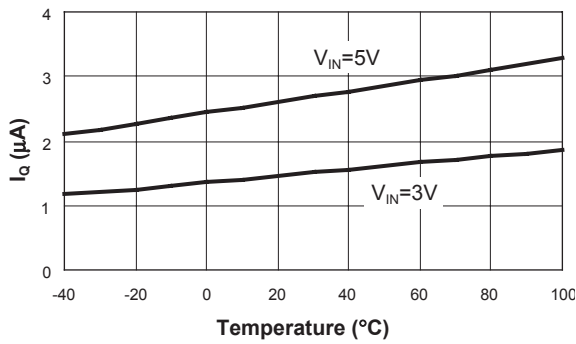

**Quiescent Current vs. Input Voltage**

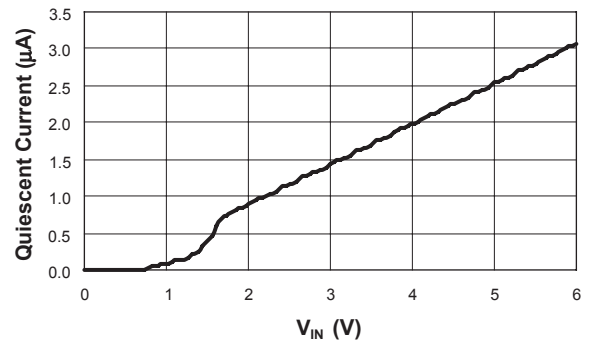

**$R_{DS(ON)}$  vs.  $V_{IN}$**

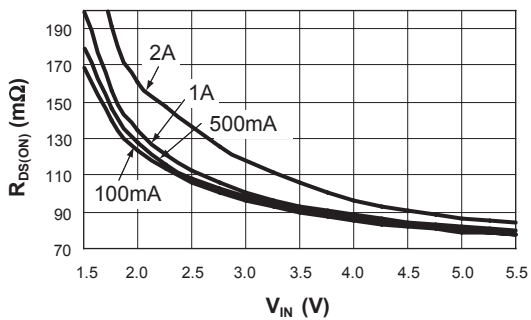

**$R_{DS(ON)}$  vs. Temperature**

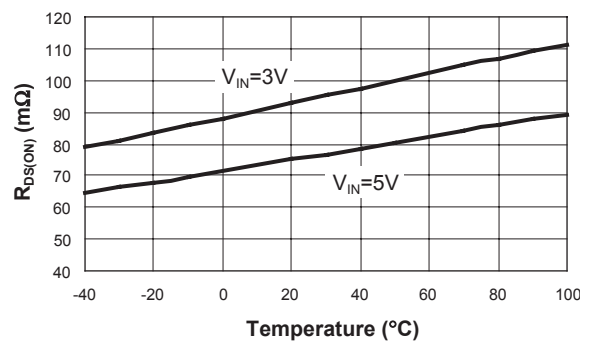

**ON/OFF Threshold vs.  $V_{IN}$**

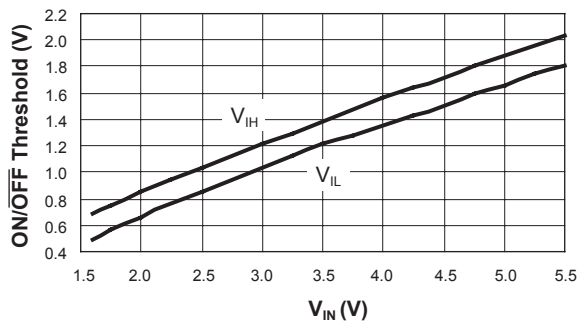

**Off Switch Current vs. Temperature**

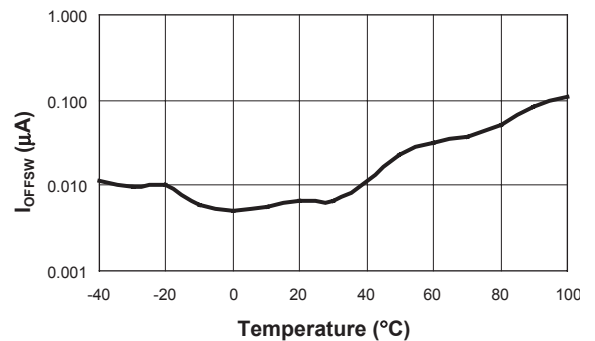

### Typical Characteristics—4280-1

(Unless otherwise noted,  $V_{IN} = 5V$ ,  $T_A = 25^\circ C$ )

**AAT4280-1 Turn-On**  
 $V_{IN}=3V$   $R_L=6\Omega$

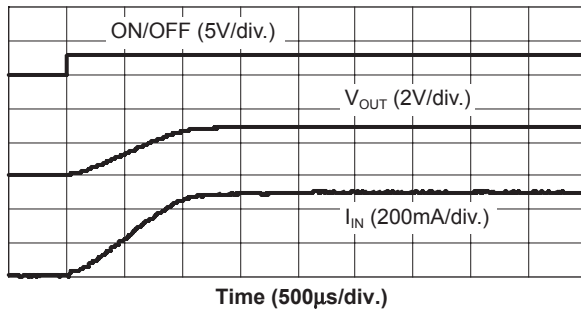

**AAT4280-1 Turn-On**  
 $V_{IN}=5V$   $R_L=10\Omega$

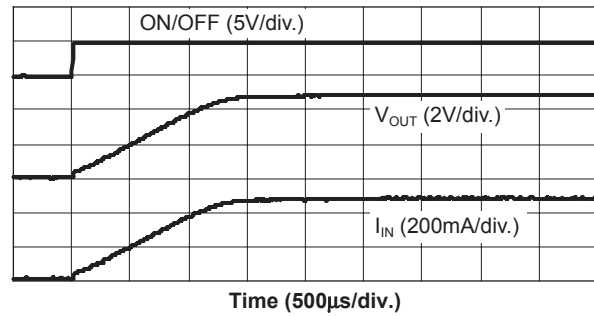

**AAT4280-1 Turn-Off**  
 $V_{IN}=3V$   $R_L=6\Omega$

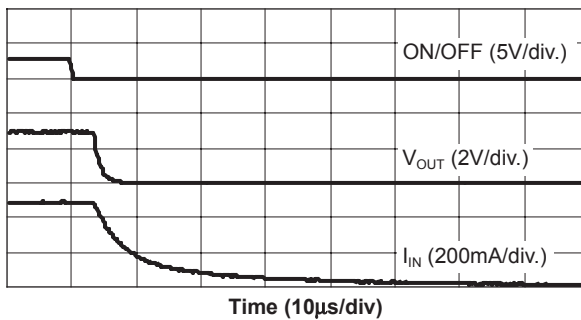

**AAT4280-1 Turn-Off**  
 $V_{IN}=5V$   $R_L=10\Omega$

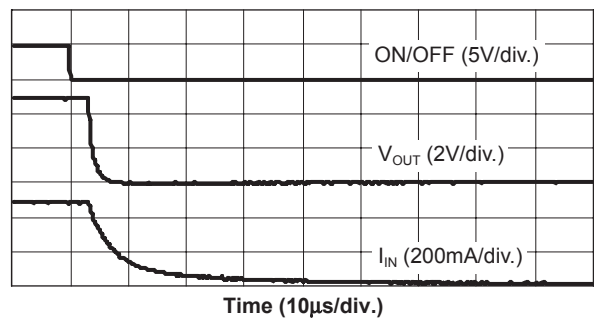

### Typical Characteristics—4280-2

(Unless otherwise noted,  $V_{IN} = 5V$ ,  $T_A = 25^\circ C$ )

**AAT4280-2 Turn-On**  
 $V_{IN}=3V$   $R_L=6\Omega$

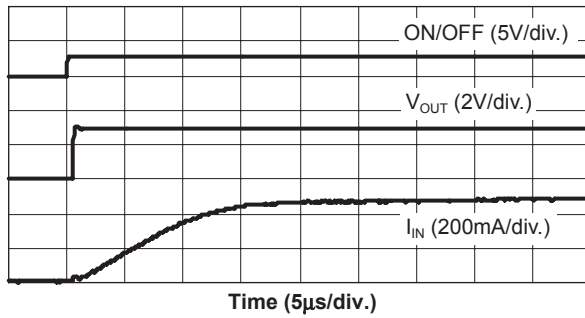

**AAT4280-2 Turn-On**  
 $V_{IN}=5V$   $R_L=10\Omega$

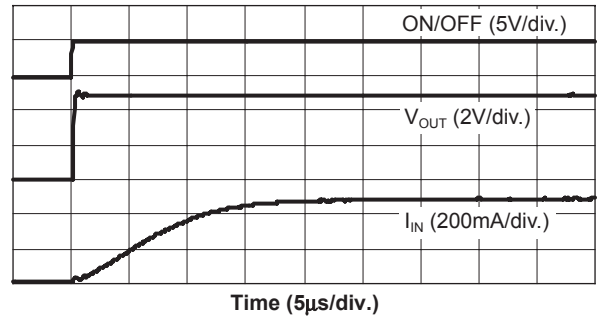

**AAT4280-2 Turn-Off**  
 $V_{IN}=3V$   $R_L=6\Omega$

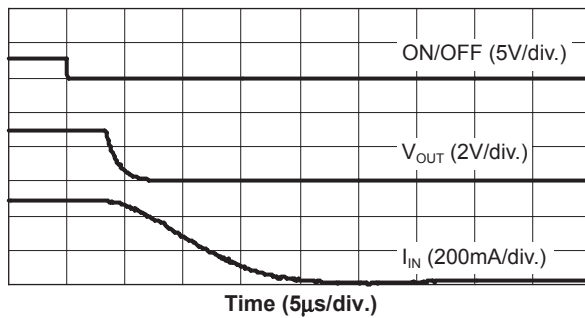

**AAT4280-2 Turn-Off**  
 $V_{IN}=5V$   $R_L=10\Omega$

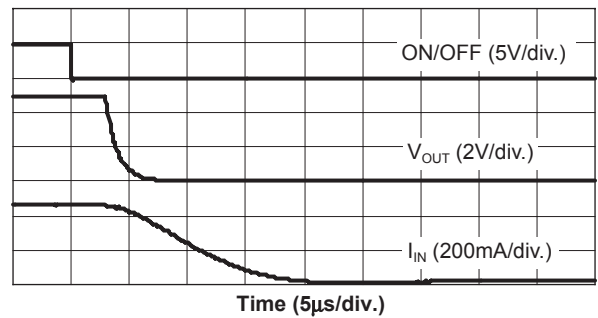

### Typical Characteristics—4280-3

(Unless otherwise noted,  $V_{IN} = 5V$ ,  $T_A = 25^\circ C$ )

**AAT4280-3 Turn-On**  
 $V_{IN}=3V$   $R_L=6\Omega$

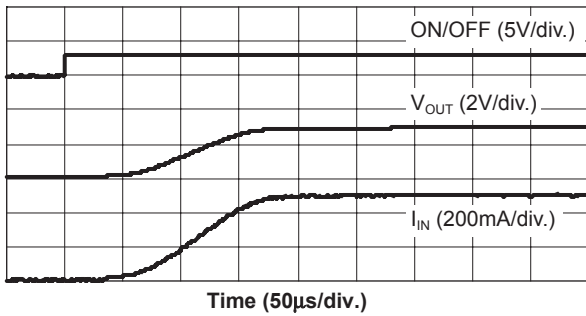

**AAT4280-3 Turn-On**  
 $V_{IN}=5V$   $R_L=10\Omega$

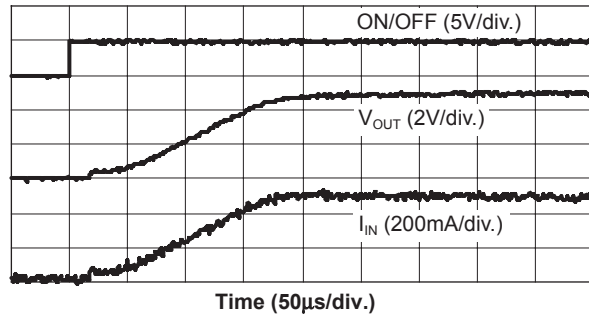

**AAT4280-3 Turn-Off**  
 $V_{IN}=3V$   $R_L=6\Omega$

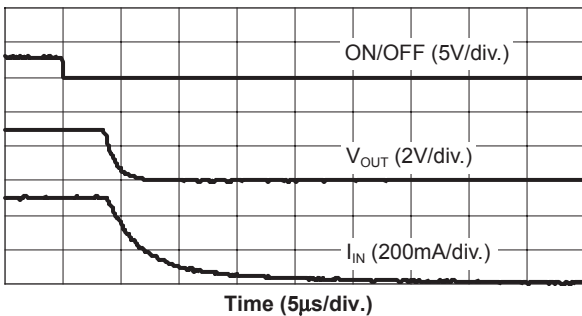

**AAT4280-3 Turn-Off**  
 $V_{IN}=5V$   $R_L=10\Omega$

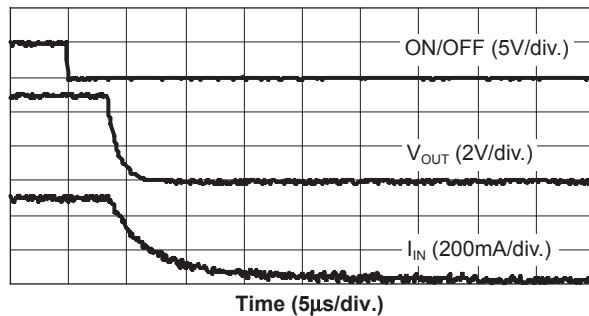



### Functional Block Diagram

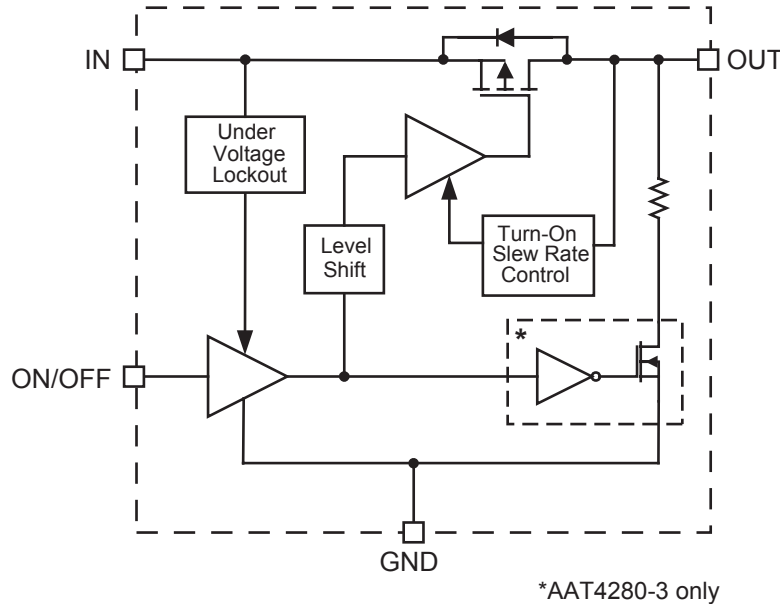

### Functional Description

The AAT4280 is a family of flexible P-channel MOSFET power switches designed for high-side load-switching applications. There are three versions of AAT4280 with different turn-on and turn-off characteristics to choose from, depending upon the specific requirements of an application. The first AAT4280-1 version has a moderate turn on slew rate feature, which reduces in-rush current when the MOSFET is turned on. This function allows the load switch to be implemented with a small input capacitor, or no input capacitor at all. During turn on slewing, the current ramps linearly until it reaches the level required for the output load condition. The proprietary turn on current control method works by careful control and monitoring of the MOSFET gate voltage. When the device is switched ON, the gate voltage is quickly increased to the threshold level of the MOSFET. Once at this level, the current begins to slew as the gate voltage is slowly increased until the MOSFET becomes fully enhanced. Once it has reached this point, the

gate is quickly increased to the full input voltage and  $R_{DS(ON)}$  is minimized. The second device version, the AAT4280-2 is a very fast switch intended for high speed switching applications. This version has no turn on slew rate control and no special output discharge features. The final switch version, the AAT4280-3 has the addition of a minimized slew rate limited turn on function and a shutdown output discharge circuit to rapidly turn off a load when the load switch is disabled through the ON/OFF pin.

All versions of the AAT4280 operate with input voltages ranging from 1.8V to 5.5V. All versions of this device have extremely low operating current, making them ideal for battery-powered applications. In cases where the input voltage drops below 1.8V, the AAT4280 MOSFET device is protected from entering into the saturation region of operation by automatically shutting down through an under voltage lockout control circuit. The ON/OFF control pin is TTL compatible and will also function with 2.5 volt to 5 volt logic systems, making the AAT4280 an ideal level shifting load-switch.

### Applications Information

#### Input Capacitor

Typically a 1 $\mu$ F or larger capacitor is recommended for  $C_{IN}$  in most applications. A  $C_{IN}$  capacitor is not required for basic operation. However,  $C_{IN}$  is useful in preventing load transients from affecting upstream circuits.  $C_{IN}$  should be located as close to the device  $V_{IN}$  pin as practically possible. Ceramic, tantalum or aluminum electrolytic capacitors may be selected for  $C_{IN}$ . There is no specific capacitor ESR requirement for  $C_{IN}$ . However, for higher current operation, ceramic capacitors are recommended for  $C_{IN}$  due to their inherent capability over tantalum capacitors to withstand input current surges from low impedance sources such as batteries in portable devices.

#### Output Capacitor

For proper slew operation, a 0.1 $\mu$ F capacitor or greater between  $V_{OUT}$  and GND is recommended. The output capacitor has no specific capacitor type or ESR requirement. If desired,  $C_{OUT}$  may be increased without limit to accommodate any load transient condition without adversely affecting the device turn on slew rate time.

#### Enable Function

The AAT4280 features an enable / disable function. This pin (ON/OFF) is compatible with both TTL or CMOS logic.

#### Reverse Output to Input Voltage Conditions and Protection

Under normal operating conditions a parasitic diode exists between the output and input of the load switch. The input voltage should always remain greater than the output load voltage maintaining a reverse bias on the internal parasitic diode. Conditions where  $V_{OUT}$  might exceed  $V_{IN}$  should be avoided since this would forward bias the internal parasitic diode and allow excessive current flow into the  $V_{OUT}$  pin and possible damage to the load switch.

In applications where there is a possibility of  $V_{OUT}$  exceeding  $V_{IN}$  for brief periods of time during normal operation, the use of a larger value  $C_{IN}$  capaci-

tor is highly recommended. A larger value of  $C_{IN}$  with respect to  $C_{OUT}$  will effect a slower  $C_{IN}$  decay rate during shutdown, thus preventing  $V_{OUT}$  from exceeding  $V_{IN}$ . In applications where there is a greater danger of  $V_{OUT}$  exceeding  $V_{IN}$  for extended periods of time, it is recommended to place a schottky diode from  $V_{IN}$  to  $V_{OUT}$  (connecting the cathode to  $V_{IN}$  and anode to  $V_{OUT}$ ). The Schottky diode forward voltage should be less then 0.45 volts.

#### Thermal Considerations and High Output Current Applications

The AAT4280 is designed to deliver a continuous output load current. The limiting characteristic for maximum safe operating output load current is package power dissipation. In order to obtain high operating currents, careful device layout and circuit operating conditions need to be taken into account.

The following discussions will assume the load switch is mounted on a printed circuit board utilizing the minimum recommended footprint as stated in the layout considerations section.

At any given ambient temperature ( $T_A$ ) the maximum package power dissipation can be determined by the following equation:

$$P_{D(MAX)} = [T_{J(MAX)} - T_A] / \Theta_{JA}$$

Constants for the AAT4280 are maximum junction temperature,  $T_{J(MAX)} = 125^\circ\text{C}$ , and package thermal resistance,  $\Theta_{JA} = 120^\circ\text{C/W}$ . Worst case conditions are calculated at the maximum operating temperature where  $T_A = 85^\circ\text{C}$ . Typical conditions are calculated under normal ambient conditions where  $T_A = 25^\circ\text{C}$ . At  $T_A = 85^\circ\text{C}$ ,  $P_{D(MAX)} = 333\text{mW}$ . At  $T_A = 25^\circ\text{C}$ ,  $P_{D(MAX)} = 833\text{mW}$ .

The maximum continuous output current for the AAT4280 is a function of the package power dissipation and the  $R_{DS}$  of the MOSFET at  $T_{J(MAX)}$ . The maximum  $R_{DS}$  of the MOSFET at  $T_{J(MAX)}$  is calculated by increasing the maximum room temperature  $R_{DS}$  by the  $R_{DS}$  temperature coefficient. The temperature coefficient ( $T_C$ ) is 2800ppm/ $^\circ\text{C}$ . Therefore,

$$\text{MAX } R_{DS} 125^\circ\text{C} = R_{DS} 25^\circ\text{C} \times (1 + T_C \times \Delta T)$$

$$\text{MAX } R_{DS} 125^\circ\text{C} = 120\text{m}\Omega \times (1 + 0.0028 \times (125^\circ\text{C} - 25^\circ\text{C})) = 154\text{m}\Omega$$

For maximum current, refer to the following equation:

$$I_{OUT(MAX)} < (P_{D(MAX)} / R_{DS})^{1/2}$$

For example, if  $V_{IN} = 5V$ ,  $R_{DS(MAX)} = 154m\Omega$  and  $T_A = 25^\circ C$ ,  $I_{OUT(MAX)} = 2.3A$ . If the output load current were to exceed 2.3A or if the ambient temperature were to increase, the internal die temperature will increase, and the device will be damaged.

Higher peak currents can be obtained with the AAT4280. To accomplish this, the device thermal resistance must be reduced by increasing the heat sink area or by operating the load switch in a duty cycle manner.

### High Peak Output Current Applications

Some applications require the load switch to operate at a continuous nominal current level with short duration high current peaks. The duty cycle for both output current levels must be taken into account. To do so, first calculate the power dissipation at the nominal continuous current level, and then add in the additional power dissipation due to the short duration high current peak scaled by the duty factor.

For example, a 4V system using an AAT4280 operates at a continuous 100mA load current level and has short 2A current peaks, as in a GSM application. The current peak occurs for 576 $\mu s$  out of a 4.61ms period.

First, the current duty cycle is calculated:

$$\% \text{ Peak Duty Cycle: } X/100 = 576\mu s / 4.61ms$$

$$\% \text{ Peak Duty Cycle} = 12.5\%$$

The load current is 100mA for 87.5% of the 4.61ms period and 2A for 12.5% of the period. Since the Electrical Characteristics do not report  $R_{DS(MAX)}$  for 4 volt operation, it must be calculated approximately by consulting the chart of  $R_{DS(ON)}$  vs.  $V_{IN}$ . The  $R_{DS}$  reported for 5 volts can be scaled by the

ratio seen in the chart to derive the  $R_{DS}$  for a 4 volt  $V_{IN}$ :  $120m\Omega \times 87m\Omega / 80m\Omega = 130m\Omega$ . De-rated for temperature:  $130m\Omega \times (1 + .0028 \times (125^\circ C - 25^\circ C)) = 166m\Omega$ . The power dissipation for a 100mA load is calculated as follows:

$$P_{D(MAX)} = I_{OUT}^2 \times R_{DS}$$

$$P_{D(100mA)} = (100mA)^2 \times 166m\Omega$$

$$P_{D(100mA)} = 1.66mW$$

$$P_{D(87.5\%D/C)} = \%DC \times P_{D(100mA)}$$

$$P_{D(87.5\%D/C)} = 0.875 \times 1.66mW$$

$$P_{D(87.5\%D/C)} = 1.45mW$$

The power dissipation for 100mA load at 87.5% duty cycle is 1.45mW. Now the power dissipation for the remaining 12.5% of the duty cycle at 2A is calculated:

$$P_{D(MAX)} = I_{OUT}^2 \times R_{DS}$$

$$P_{D(2A)} = (2A)^2 \times 166m\Omega$$

$$P_{D(2A)} = 664mW$$

$$P_{D(12.5\%D/C)} = \%DC \times P_{D(2A)}$$

$$P_{D(12.5\%D/C)} = 0.125 \times 664mW$$

$$P_{D(12.5\%D/C)} = 83mW$$

The power dissipation for 2A load at 12.5% duty cycle is 83mW. Finally, the two power figures are summed to determine the total true power dissipation under the varied load.

$$P_{D(total)} = P_{D(100mA)} + P_{D(2A)}$$

$$P_{D(total)} = 1.45mW + 83mW$$

$$P_{D(total)} = 84.5mW$$

The maximum power dissipation for the AAT4280 operating at an ambient temperature of 85 $^\circ C$  is 333mW. The device in this example will have a total power dissipation of 84.5mW. This is well within the thermal limits for safe operation of the device, in fact, at 85 $^\circ C$ , the AAT4280 will handle a 2A pulse for up to 50% duty cycle. At lower ambient temperatures the duty cycle can be further increased.

### Printed Circuit Board Layout Recommendations

For proper thermal management, and to take advantage of the low  $R_{DS(ON)}$  of the AAT4280, a few circuit board layout rules should be followed:  $V_{IN}$  and  $V_{OUT}$  should be routed using wider than normal traces, and GND should be connected to a ground plane. To maximize package thermal dissipation and power handling capacity of the AAT4280 SOT23-6/SC70JW-8 package, the ground plane area connected to the ground pins should be made as large as possible. For best performance,  $C_{IN}$  and  $C_{OUT}$  should be placed close to the package pins.

### Evaluation Board Layout

The AAT4280 evaluation layout follows the printed circuit board layout recommendations, and can be used for good applications layout. Refer to Figures 1 through 3.

Note: Board layout shown is not to scale.

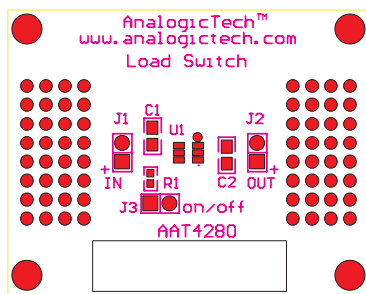

Figure 1: Evaluation board top side silk screen layout / assembly drawing

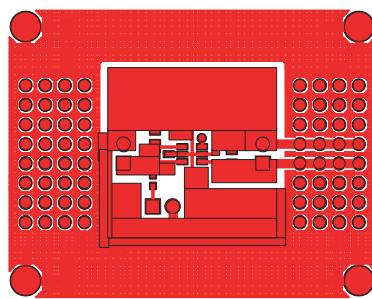

Figure 2: Evaluation board component side layout

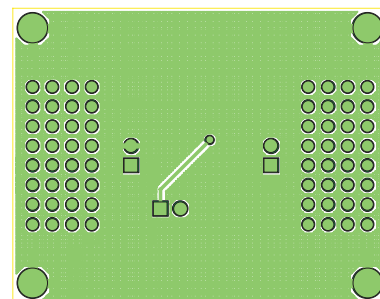

Figure 3: Evaluation board solder side layout

### Ordering Information

| Device Option | Package  | Marking <sup>1</sup> | Part Number (Tape and Reel) |
|---------------|----------|----------------------|-----------------------------|
| AAT4280-1     | SOT23-6  | COXY                 | <b>AAT4280IGU-1-T1</b>      |
| AAT4280-2     | SOT23-6  | BZXY                 | <b>AAT4280IGU-2-T1</b>      |
| AAT4280-3     | SOT23-6  | CJXY                 | <b>AAT4280IGU-3-T1</b>      |
| AAT4280-1     | SC70JW-8 | COXY                 | <b>AAT4280IJS-1-T1</b>      |
| AAT4280-2     | SC70JW-8 | BZXY                 | <b>AAT4280IJS-2-T1</b>      |
| AAT4280-3     | SC70JW-8 | CJXY                 | <b>AAT4280IJS-3-T1</b>      |

Note: Sample stock is generally held on all part numbers listed in **BOLD**.

Note 1: XYY = assembly and date code.

### Package Information

#### SOT23-6

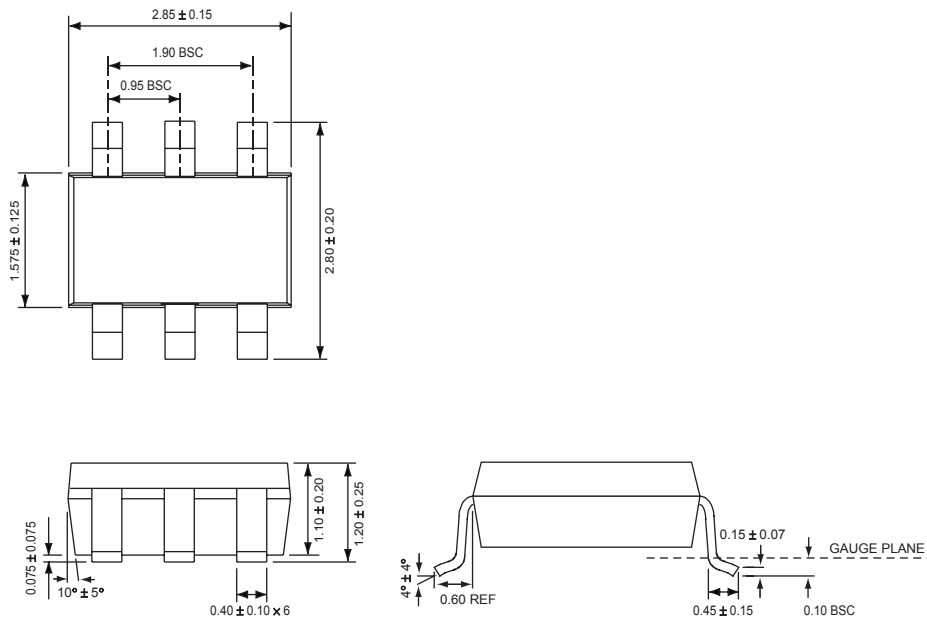

All dimensions in millimeters.

### SC70JW-8

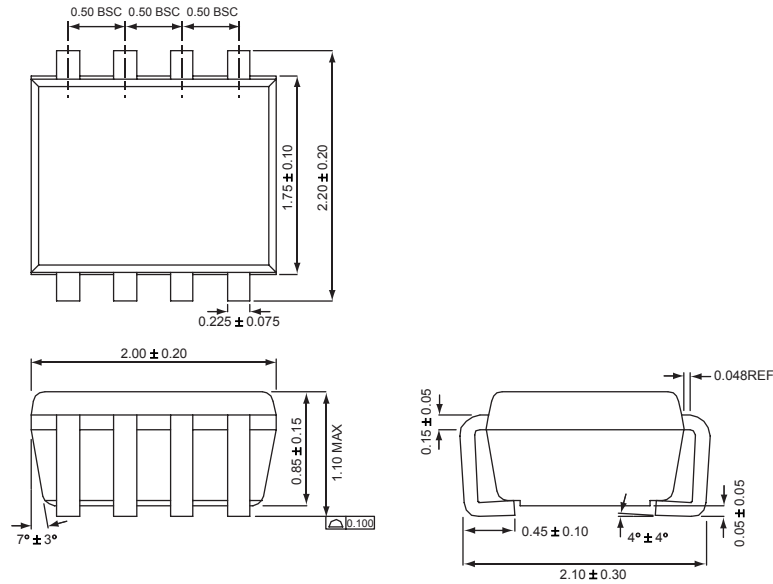

All dimensions in millimeters.

AnalogicTech cannot assume responsibility for use of any circuitry other than circuitry entirely embodied in an AnalogicTech product. No circuit patent licenses, copyrights, mask work rights, or other intellectual property rights are implied.

AnalogicTech reserves the right to make changes to their products or specifications or to discontinue any product or service without notice, and advise customers to obtain the latest version of relevant information to verify, before placing orders, that information being relied on is current and complete. All products are sold subject to the terms and conditions of sale supplied at the time of order acknowledgement, including those pertaining to warranty, patent infringement, and limitation of liability.

AnalogicTech warrants performance of its semiconductor products to the specifications applicable at the time of sale in accordance with AnalogicTech's standard warranty. Testing and other quality control techniques are utilized to the extent AnalogicTech deems necessary to support this warranty. Specific testing of all parameters of each device is not necessarily performed.

**Advanced Analogic Technologies, Inc.**  
 830 E. Arques Avenue, Sunnyvale, CA 94085  
 Phone (408) 737-4600  
 Fax (408) 737-4611